

ICC-ES Evaluation Report

ESR-2613

Reissued June 2024

This report also contains:



- LABC Supplement

Subject to renewal June 2025

- FBC Supplement

ICC-ES Evaluation Reports are not to be construed as representing aesthetics or any other attributes not specifically addressed, nor are they to be construed as an endorsement of the subject of the report or a recommendation for its use. There is no warranty by ICC Evaluation Service, LLC, express or implied, as to any finding or other matter in this report, or as to any product covered by the report.

Copyright © 2024 ICC Evaluation Service, LLC. All rights reserved.

<p>DIVISION: 06 00 00— WOOD, PLASTICS, AND COMPOSITES</p> <p>Section: 06 05 23— Wood, Plastic, and Composite Fastenings</p>	<p>REPORT HOLDER: SIMPSON STRONG-TIE COMPANY INC.</p> 	<p>EVALUATION SUBJECT: SIMPSON STRONG-TIE® HURRICANE AND SEISMIC STRAPS AND TIES FOR WOOD FRAMING</p>	
---	---	---	---

1.0 EVALUATION SCOPE

Compliance with the following codes:

- 2021, 2018, 2015, and 2012 [International Building Code® \(IBC\)](#)
- 2021, 2018, 2015, and 2012 [International Residential Code® \(IRC\)](#)

For evaluation for compliance with codes adopted by the [Los Angeles Department of Building and Safety \(LADBS\)](#), see [ESR-2613 LABC and LARC Supplement](#).

Property evaluated:

- Structural

2.0 USES

The Simpson Strong-Tie® hurricane and seismic straps and ties described in this report are used as wood framing connectors in accordance with Section [2304.10.4](#) of the 2021 IBC, Section [2304.10.3](#) of the 2018 and 2015 IBC and Section [2304.9.3](#) of the 2012 IBC. The products may also be used in structures regulated under the IRC when an engineered design is submitted in accordance with Section [R301.1.3](#) of the IRC.

3.0 DESCRIPTION

3.1 General:

The Simpson Strong-Tie hurricane and seismic straps and ties recognized in this report are installed to resist design forces on wood-frame construction resulting from the application of the most critical effects of the load combinations prescribed by code that include wind or seismic loads.

3.1.1 Hurricane Ties: Hurricane ties are used to anchor wood rafters or joists to wood wall plates or studs or to anchor wood studs to wood sill plates. The H6 and H7Z ties are formed from No. 16 gage galvanized steel and the H1, H1A, H2.5A, H3, H10A, H16, H16S, H16-2 and H16-2S ties are formed from No. 18 gage galvanized steel. See [Table 1](#) for tie model numbers, tie dimensions, fastener schedules, and allowable loads. See [Figures 1a](#) and [1b](#) for illustrations of the hurricane ties recognized in this report, and [Figure 1c](#) for illustrations of installation configurations with designated allowable load directions.

3.1.2 HS24 Hurricane Tie: The HS24 hurricane tie anchors wood rafters or trusses to wood wall top plates. The HS24 connector is formed from No. 18 gage galvanized steel. See [Table 2](#) for required fasteners and allowable loads. See [Figure 2](#) for a drawing of the HS24 tie and a typical installation detail.

3.1.3 LTS, MTS/MTSC, and HTS/HTSC Series Twist Straps: The LTS, MTS, MTSC, HTS, and HTSC series twist straps are used to anchor wood trusses or rafters to wood wall double top plates, wood studs, wood beams, or wood rim boards. The LTS, MTS (MTSC), and HTS (HTSC) series twist straps are formed from No. 18, No. 16, and No. 14 gage galvanized steel, respectively. See [Table 3](#) for strap model numbers, overall strap lengths, required fasteners, and allowable uplift loads when installed with different fastener schedules. See [Figure 3](#) for a drawing of an LTS12 twist strap and two typical MTS strap installations.

3.1.4 HTSQ: The HTSQ twist strap is used as a tension connector between two wood members and is formed from No. 14 gage galvanized steel. See [Table 4](#) for strap model numbers, required fasteners, and the assigned allowable uplift load. See [Figure 4](#) for a drawing of the HTSQ strap.

3.1.5 SP and SPH Series Stud Plate Connectors: The SP1 connector fastens one edge of a wood stud to the contiguous edge of a wood sill plate, and the SP2 connector fastens to one side of a wood double top plate and to the contiguous edge of a wood stud. The SP4, SP6, SP8, SPH4, SPH6, and SPH8 are 1¹/₄-inch-wide (32 mm) U-shaped straps with a horizontal portion that bears against the wood wall top plates or sill plates and two vertical legs that are nailed to the edges of a wood stud. The SP and SPH connectors are fabricated from No. 20 and No. 18 gage galvanized steel, respectively. See [Table 5](#) for SP and SPH models, connector dimensions, required fasteners, and allowable uplift loads. See [Table 5](#) for drawings of the SP1 and SP2 connector, and of typical stud-to-plate connection details for the SP1, SP2, SP4, and SPH4 connectors.

3.1.6 RSP4 Reversible Stud Plate Ties: The RSP4 tie plates are used to connect a nominally 2-inch-wide wood stud to either a top or sill plate of a wood framed wall. The RSP4 tie connector is fabricated from No. 20 gage galvanized steel. See [Table 6](#) for required fasteners and allowable loads. See [Figure 6a](#) for a drawing of the RSP4 connector showing overall dimensions; [Figure 6b](#) for a drawing of a typical RSP4 installation connecting a wood double top plate to a wood stud; and [Figure 6c](#) for a typical RSP4 installation connecting a wood stud to a wood sill plate.

3.1.7 SSP, DSP and TSP Stud Plate Connectors: The SSP stud-to-plate connector is used to provide a positive connection between a single wood stud and the top or sill plate of the same wood wall, and the DSP stud-to-plate connector is used to provide a positive connection between a double wood stud and the wood wall top or sill plate of the same wood wall. The TSP stud-to-plate connector is used to provide a positive connection between a wood roof rafter or wood stud and double top plate, or wood stud and sill plate of the same wood wall. The SSP and DSP connectors are fabricated from No. 18 gage galvanized steel. The TSP connectors are fabricated from No. 16 gage galvanized steel. See [Table 7](#) for required fasteners and allowable uplift loads. See [Figure 7](#) for drawings of the SSP, DSP and TSP connectors showing overall dimensions; a drawing of an SSP installation connecting a stud to a sill plate; a drawing of a DSP installation connecting a double wood stud assembly to a top plate, and a drawing of a TSP installation connecting a stud to a sill plate.

3.1.8 MGT, HGT, and VGT Girder Tiedown Brackets: The MGT, HGT, and VGT girder tiedown brackets are used to provide a positive connection between wood roof beams or multi-ply wood roof trusses and wood posts vertically aligned to support the end reaction of the beam or truss member. The MGT tiedown bracket consists of a main structural steel component with prepunched fastener holes that is installed onto the side of, or wrapped over the top of, a wood roof truss. The MGT tiedown brackets are fabricated from No. 12 gage steel and are supplied with the ³/₈ inch (9.5 mm) thick base plate. The HGT tiedown bracket is a U-shaped bracket that is installed over the top chord of the roof truss having a slope from 3:12 (14 degrees) to 8:12 (34 degrees). The HGT tiedown brackets are fabricated from No. 7 gage steel, and are supplied with insert plates and crescent washers. The VGT is a U-shaped bracket with prepunched fastener holes in the face flanges. The VGT can be installed onto the side of roof trusses with slopes up to 8:12 (34 degrees) or on bottom chords designed to transfer load. The VGTL/R have a concealed flange for installation on rafters or trusses with no overhang. The VGT tiedown brackets are fabricated from No. 7 gage steel and are supplied with a crescent washer. Other components required for the connection, such as the anchor rods and hold-down or tie-down devices, that must be used to form a complete load path to resist design uplift forces from their point of origin to the load-resisting elements, that is, the vertically aligned supporting wood post, must be designed and specified by the registered design professional. See [Table 8](#) for tiedown bracket models, bracket dimensions, fastener schedules, and allowable uplift loads. See [Figure 8](#) for a drawing of the MGT, HGT-2, and VGT tiedown brackets.

3.2 Materials:

3.2.1 Steel: Unless otherwise noted, the connectors described in this report are fabricated from [ASTM A653](#), SS designation, Grade 33, galvanized steel with a minimum yield strength, F_y , of 33,000 psi (227 MPa) and a minimum tensile strength, F_u , of 45,000 psi (310 MPa). The HTS and HTSQ twist straps, the SSP, DSP, and

TSP stud-to-plate ties, the H2.5A, H16, H16S, H16-2, and H16-2S hurricane ties, and the MGT girder tiedown are fabricated from ASTM A653, SS designation, Grade 40, steel with a minimum yield strength of 40,000 psi (275 MPa) and a minimum tensile strength of 55,000 psi (379 MPa).

The body of the HGT girder tiedown bracket is fabricated from [ASTM A1011](#), SS designation, Grade 33, hot rolled steel with a minimum yield strength of 33,000 psi (227 MPa) and a minimum tensile strength of 52,000 psi (358 MPa), and the crescent washers of the HGT bracket and MGT bearing plate are fabricated from [ASTM A36](#) steel with a minimum yield strength of 36,000 psi (248 MPa) and a minimum tensile strength of 58,000 psi (399 Mpa).

Base-metal thicknesses for the connectors in this report are as follows:

NOMINAL THICKNESS (gage)	MINIMUM BASE-METAL THICKNESS (inch)
No. 3	0.2285
No. 7	0.1705
No. 10	0.1275
No. 12	0.0975
No. 14	0.0685
No. 16	0.0555
No. 18	0.0445
No. 20	0.0335

For SI: 1 inch = 25.4 mm.

The galvanized connectors have a minimum G90 zinc coating specification in accordance with ASTM A653. Some models (designated with a model number ending with Z) are available with a G185 zinc coating specification in accordance with ASTM A653. Some models (designated with a model number ending with HDG) are available with a hot-dip galvanization, also known as “batch” galvanization, in accordance with [ASTM A123](#), with a minimum specified coating weight of 2.0 ounces of zinc per square foot of surface area (600 g/m²), total for both sides. Model numbers in this report do not include the Z or HDG ending, but the information shown applies.

The HGT Girder Tiedown Brackets have a painted finish and may also be available with the HDG finish.

The lumber treater or holder of this report (Simpson Strong-Tie Company) should be contacted for recommendations on minimum corrosion resistance of steel connectors in contact with the specific proprietary preservative treated or fire retardant treated lumber.

3.2.2 Wood: Supporting wood members to which these connectors are fastened must be solid sawn lumber, glued-laminated lumber, or engineered lumber [such as Laminated Veneer Lumber (LVL), Parallel Strand Lumber (PSL), and Laminated Strand Lumber (LSL)] having dimensions consistent with the connector dimensions shown in this report. Unless otherwise noted, supporting wood members and supported members must have an assigned minimum specific gravity of 0.50 (minimum equivalent specific gravity of 0.50 for engineered lumber), except as noted in [Table 5](#) for the SPH stud plate tie connectors, which provides values for which lumber members having assigned minimum specific gravities of 0.50 and 0.55 are required; and [Table 7](#) for the SSP and DSP stud-to-plate tie connectors, which permits lumber having assigned minimum specific gravities of 0.50 and 0.43. The lumber used with the connectors described in this report must have a maximum moisture content of 19 percent (16 percent for engineered lumber) except as noted in Section 4.1.

The thickness of the wood members must be equal to or greater than the length of the fasteners specified in the tables in this report, except if noted otherwise in the tables and accompanying footnotes in this report, or as required by wood member design, whichever controls.

3.2.3 Fasteners: Bolts, at a minimum, must comply with ASTM A36 or [A307](#). SDS Wood Screws used with connectors described in [Table 4](#) and [Table 8](#) must be Simpson Strong-Tie SDS wood screws in [ESR-2236](#). Nails used for connectors, straps, and ties described in this report must be bright or hot-dipped galvanized carbon steel nails complying with [ASTM F1667](#) with the minimum dimensions and bending yield strengths (Fyb) shown in the following table. Alternatively, nails of other materials or finishes may be used when they are recognized in an ICC-ES evaluation report as having bending yield strength and withdrawal capacity equal to or better than those of a bright carbon steel nail of the same nominal diameter.

FASTENERS	NAIL DIAMETER (inch)	NAIL LENGTH (inches)	F_{yb} (psi)
0.131" x 1½"	0.131	1½	100,000
0.131" x 2½"	0.131	2½	100,000
0.148" x 1½"	0.148	1½	90,000
0.148" x 3"	0.148	3	90,000

For **SI**: 1 inch = 25.4 mm, 1 psi = 6894.8 Pa.

Fasteners used in contact with preservative-treated or fire-retardant-treated lumber must be hot-dipped galvanized carbon steel nails. Alternatively, nails of other materials or finishes may be used when they are recognized in an ICC-ES evaluation report for use in the applicable treated lumber.

4.0 DESIGN AND INSTALLATION

4.1 Design:

The tabulated allowable loads shown in this report are based on allowable stress design (ASD) and include the load duration factor, C_D , corresponding with the applicable loads in accordance with the *National Design Specification[®] for Wood Construction* (NDS).

Tabulated allowable loads apply to products connected to wood used under dry conditions and where sustained temperatures are 100°F (37.8°C) or less. When products are installed to wood having a moisture content greater than 19 percent (16 percent for engineered wood products), or when wet service is expected, the allowable loads must be adjusted by the wet service factor, C_M , specified in the NDS. When connectors are installed in wood that will experience sustained exposure to temperatures exceeding 100°F (37.8°C), the allowable loads in this report must be adjusted by the temperature factor, C_t , specified in the NDS.

Connected wood members must be analyzed for load-carrying capacity at the connection in accordance with the NDS.

4.2 Installation:

Installation of the connectors must be in accordance with this evaluation report and the manufacturer's published installation instructions. In the event of a conflict between this report and the manufacturer's published installation instructions, this report governs.

4.3 Special Inspection:

4.3.1 Main Wind-force-resisting Systems under the IBC: Periodic special inspection must be conducted for components within the main wind-force-resisting system, where required in accordance with Sections [1704.2](#) and [1705.12](#) of 2021 IBC, Sections [1704.2](#) and [1705.11](#) of the 2018 and 2015 IBC, and Sections [1704.2](#) and [1705.10](#) of the 2012 IBC.

4.3.2 Seismic-force-resisting Systems under the IBC: Periodic special inspection must be conducted for components within the seismic-force-resisting system, in accordance with Sections [1704.2](#) and [1705.13](#) of the 2021 IBC, Sections [1704.2](#) and [1705.12](#) of the 2018 and 2015 IBC, and Sections [1704.2](#) and [1705.11](#) of the 2012 IBC.

4.3.3 Installations under the IRC: Special inspections are normally not required for connectors used in structures regulated under the IRC. However, for components and systems requiring an engineered design in accordance with IRC Section [R301](#), periodic special inspection must be in accordance with Sections 4.3.1 and 4.3.2 of this report.

5.0 CONDITIONS OF USE:

The Simpson Strong-Tie Hurricane and Seismic Straps and Ties described in this report comply with, or are suitable alternatives to what is specified in, those codes listed in Section [1.0](#) of this report, subject to the following conditions:

- 5.1 The connectors must be manufactured, identified and installed in accordance with this report and the manufacturer's published installation instructions. A copy of the instructions must be available at the jobsite at all times during installation.
- 5.2 Calculations showing compliance with this report must be submitted to the code official. The calculations must be prepared by a registered design professional where required by the statutes of the jurisdiction in which the project is to be constructed.
- 5.3 Adjustment factors noted in Section 4.1 and the applicable codes must be considered, where applicable.

- 5.4 Connected wood members and fasteners must comply, respectively, with Sections 3.2.2 and 3.2.3 of this report.
- 5.5 Use of connectors with preservative or fire retardant treated lumber must be in accordance with Section [3.2.1](#) of this report. Use of fasteners with preservative or fire-retardant treated lumber must be in accordance with Section 3.2.3 of this report.

6.0 EVIDENCE SUBMITTED

Data in accordance with the [ICC-ES Acceptance Criteria for Joist Hangers and Similar Devices \(AC13\)](#), dated October 2018 (editorially revised December 2020).

7.0 IDENTIFICATION

- 7.1 The products described in this report are identified with a die-stamped label or adhesive label indicating the name of the manufacturer (Simpson Strong-Tie), the model number, and the number of an index evaluation report ([ESR-2523](#)) that is used as an identifier for the products recognized in this report.
- 7.2 The report holder's contact information is the following:

SIMPSON STRONG-TIE COMPANY INC.
5956 WEST LAS POSITAS BOULEVARD
PLEASANTON, CALIFORNIA 94588
(800) 999-5099
www.strongtie.com

TABLE 1—HURRICANE TIES

MODEL NO.	FASTENERS (Quantity-Type)			ALLOWABLE LOADS ^{1,2} (lbs)			
	To Rafter	To Plates	To Stud	Connection Configurations ³	Uplift ^{4,5} C _D =1.6	Lateral ^{6,7} C _D =1.6	
						F ₁	F ₂
H1	6-0.131" x 1 1/2"	4-0.131" x 2 1/2"	—	1	470	510	190
H1A	4-0.131" x 1 1/2"	4-0.131" x 1 1/2"	—		545	420	265
H10A	9-0.148" x 1 1/2"	9-0.148" x 1 1/2"	—		1,040	565	285
H2.5A	5-0.131" x 2 1/2"	5-0.131" x 2 1/2"	—	2	700	110	110
H3	4-0.131" x 2 1/2"	4-0.131" x 2 1/2"	—		400	210	170
H6	—	8-0.131" x 2 1/2"	8-0.131" x 2 1/2"	3	930	—	—
	8-0.131" x 2 1/2"	—	8-0.131" x 2 1/2"	3A	1,230	—	—
H7Z	4-0.131" x 2 1/2"	2-0.131" x 2 1/2"	8-0.131" x 2 1/2"	4	830	410	—
H16 ^{8,9}	2-0.148" x 1 1/2"	10-0.148" x 1 1/2"	—	5	1,370	—	—
H16S ^{8,9}	2-0.148" x 1 1/2"	10-0.148" x 1 1/2"	—		1,370	—	—
H16-2 ^{8,9}	2-0.148" x 1 1/2"	10-0.148" x 1 1/2"	—		1,370	—	—
H16-2S ^{8,9}	2-0.148" x 1 1/2"	10-0.148" x 1 1/2"	—		1,370	—	—

For SI: 1 inch = 25.4 mm, 1 lbs = 4.45 N.

¹Allowable loads are for one anchor installed to a minimum nominal 2x supported and minimum nominal 2x supporting wood member. A rafter minimum actual thickness of 2 1/2 inches must be used when framing anchors are installed on each side of the rafter and on the same side of the plate.

²Allowable simultaneous loads in more than one direction on a single connector must be evaluated as follows:

Design Uplift / Allowable Uplift +

Design Lateral Parallel to Plate / Allowable Lateral Parallel to Plate +

Design Lateral Perpendicular to Plate / Allowable Lateral Perpendicular to Plate ≤ 1.0.

The three terms in the unity equation consider all possible forces that the hurricane tie may be designed and installed to resist. The number of terms that must be considered for simultaneous loading is determined by the registered design professional and is dependent on the method of calculating wind forces and the assumed load path that the connector is designed to resist.

³Connection Configurations³ shown in Figure 1c (next page) indicate the load directions F₁ and F₂, and are details showing connector installations on the outside of the wall for clarity. Installation on the inside of the wall is acceptable to achieve the tabulated allowable loads.

⁴Connections in the same area (i.e. truss to plate connector and plate to stud connector) must be on installed on the same side of the wall to achieve the tabulated allowable uplift loads and ensure a continuous load path.

⁵Allowable uplift loads have been increased for wind or earthquake loading, and no further increase is allowed. Allowable loads must be reduced when other load durations govern.

⁶Allowable lateral loads in the F₁ direction must not be used to replace diaphragm boundary members or nailing or replace solid blocking required by code to laterally support the ends of joists/rafters.

⁷Additional shear transfer elements must be considered the connector installation induces cross grain bending or tension of the truss or rafter members.

⁸H16, H16S, H16-2, and H16-2S straps can be installed onto the top plates or wall studs below.

⁹H16, H16S, H16-2, and H16-2S are pre-sloped at a 5:12 pitch and can be used on pitches from 3:12 to 7:12. The minimum heel height required is 4". The maximum heel height is 13 1/2" (Use H16 or H16-2)

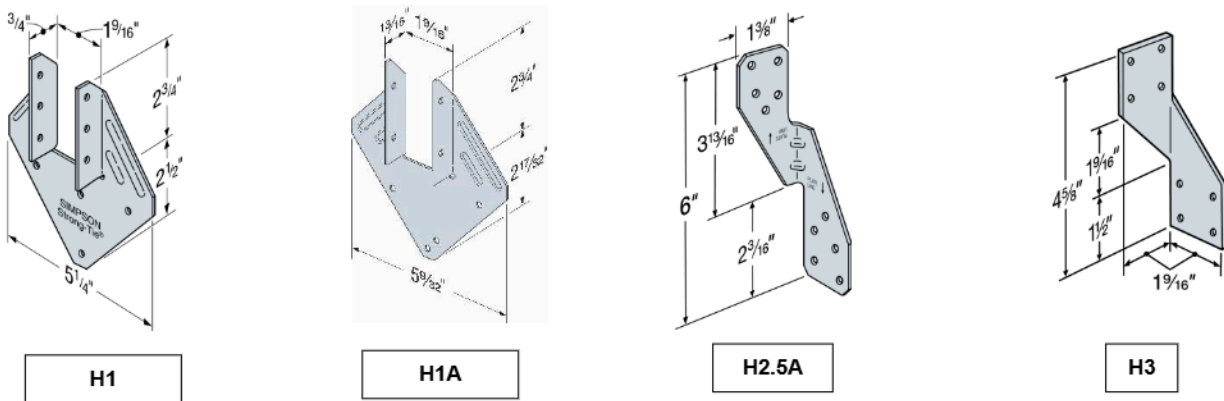

FIGURE 1a—H1, H1A, H2.5A, AND H3 HURRICANE TIES

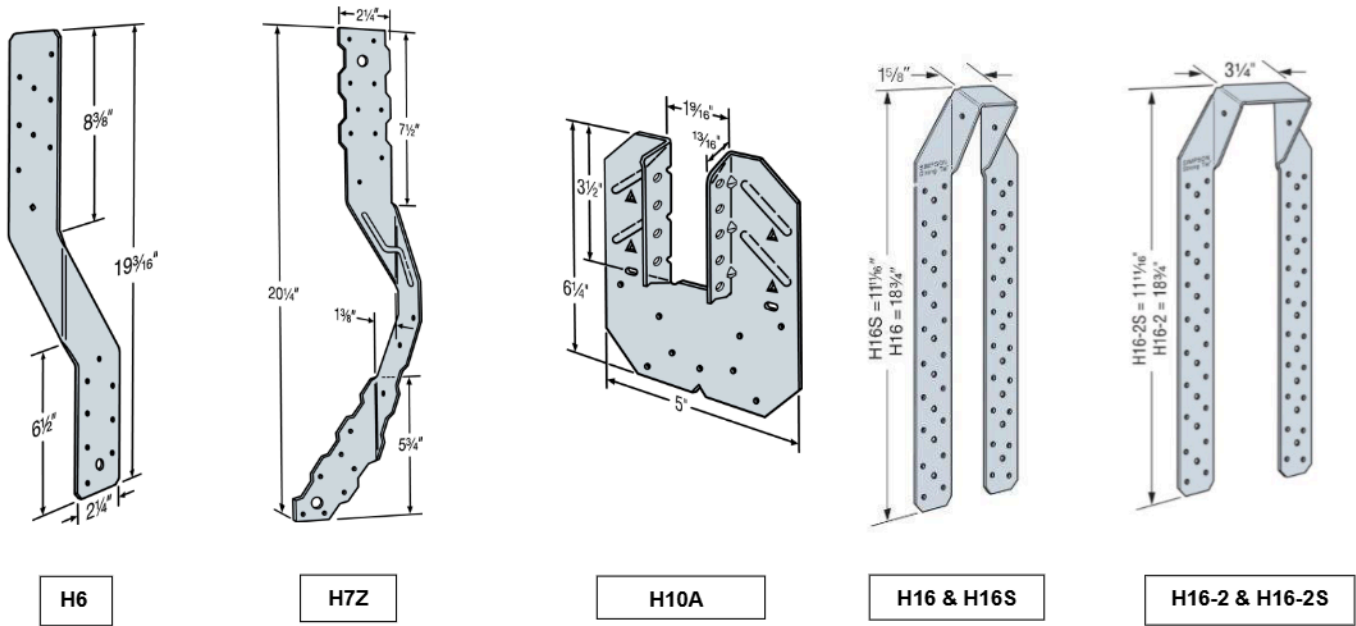

FIGURE 1b— H6, H7Z, H10A, H16, H16S, H16-2 AND H16-2S HURRICANE TIES

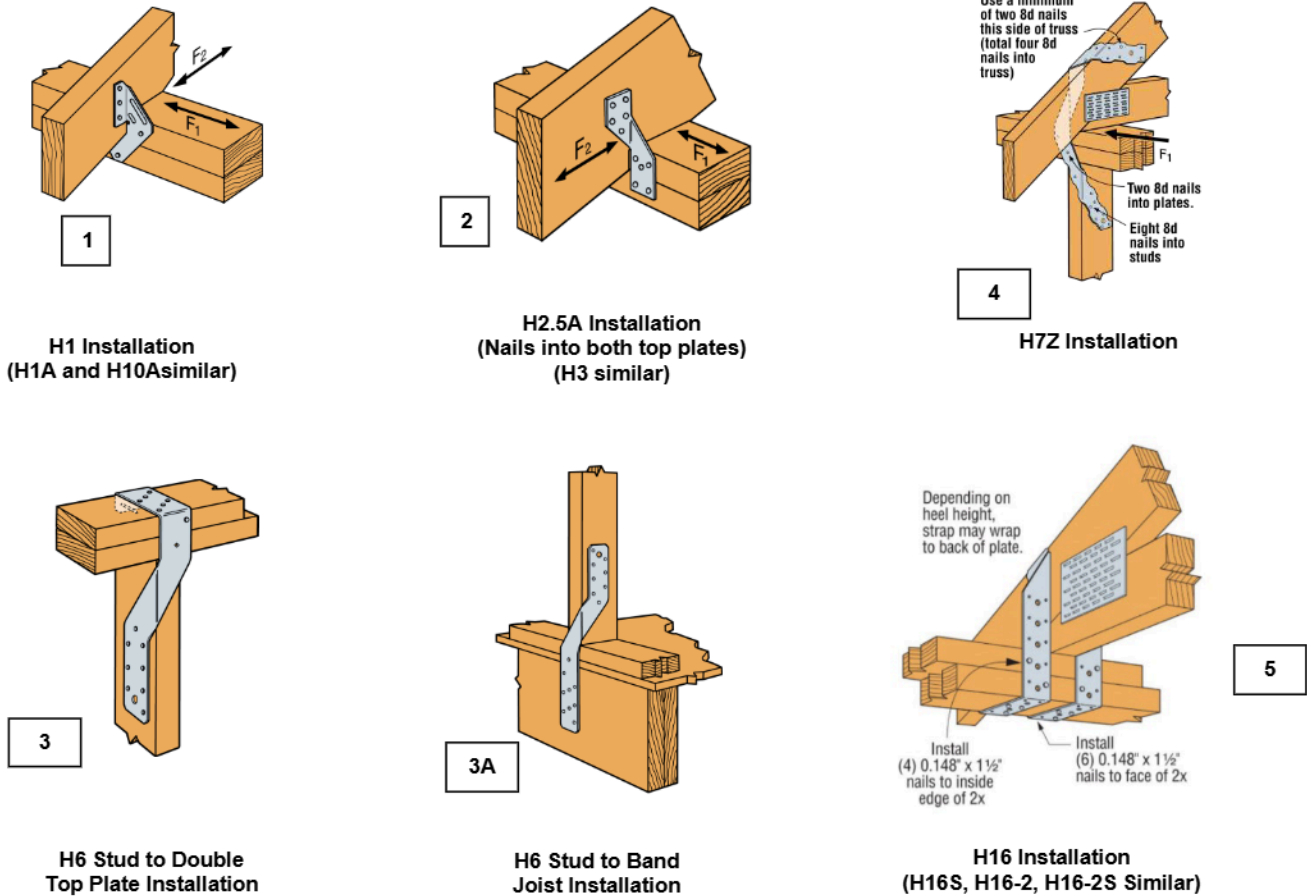

FIGURE 1c—CONNECTION CONFIGURATIONS OF HURRICANE TIE INSTALLATIONS SPECIFIED IN TABLE 1

TABLE 2—HS24 HURRICANE TIE

MODEL NO.	FASTENERS ¹ (Quantity-Type)		ALLOWABLE LOADS (lbs) C _D =1.6		
	To Rafter or Truss	To Double Top Plate	Uplift ²	Lateral ^{3,4,5}	
				F ₁	F ₂
HS24	8–0.131" x 1½" & 2–0.131" x 2½" (slant)	8–0.131" x 1½"	605	645	1,100
	8–0.131" x 1½"	8–0.131" x 1½"	625	625	680

For SI: 1 inch = 25.4 mm, 1 lbs = 4.5 N.

¹"Slant" nailing refers to 8d common nails installed as toenails on each side of the connector. The nails must be driven through the connector at an angle approximately 30° with the rafter/truss member with the nail penetrating through the rafter/truss member into the wood double top plate.

²The uplift loads have been increased for wind or earthquake loading. No further increase is allowed. Allowable loads must be reduced when other load durations govern.

³Allowable lateral loads in the F₁ direction must not be used to replace diaphragm boundary members or nailing or replace solid blocking required by code to laterally support the ends of joists/rafters.

⁴Additional shear transfer elements must be considered the connector installation induces cross grain bending or tension of the truss or rafter member.

⁵F₁ load direction is parallel to plate, and F₂ load direction is perpendicular to plate.

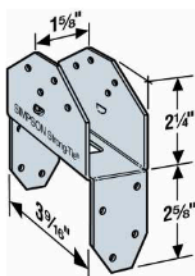

HS24 Dimensions
U.S. Patents
5,603,580

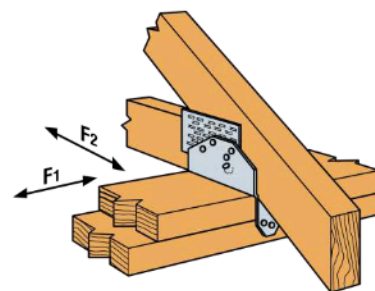

HS24 Installation and Allowable Load Directions

FIGURE 2—HS24 HURRICANE TIE

TABLE 3—LTS, MTS, AND HTS TWIST STRAPS

TWIST STRAP SERIES	MODEL NO.	STRAP LENGTH (in)	FASTENERS ¹ (Quantity-Type)	ALLOWABLE UPLIFT LOADS ^{2,3} (lbs)
			0.148" x 1½" Nails	0.148" x 1½" Nails
				C _D = 1.6
LTS ⁴	LTS12	12	12	645
	LTS16	16		
	LTS20	20		
MTS ⁴	MTS12	12	14	990
	MTS16	16		
	MTS20	20		
	MTS24C	24		
	MTS30	30		
	MTS30C	30		
HTS ⁵	HTS16	16	16	1,415
	HTS20	20		
	HTS24	24		
	HTS30	30		
	HTS30C	30		

For SI: 1 inch = 25.4 mm, 1 lbs = 4.45 N

¹Half of the fasteners must be installed on each end of the strap to achieve the allowable uplift load.

²Tabulated allowable uplift loads must be selected based on duration of load as permitted by the applicable building code.

³Tabulated allowable uplift loads have been increased for wind or earthquake loading. No further increase is allowed. Allowable loads must be reduced when other load durations govern.

⁴Each model of the LTS and MTS twist strap series (except for the MTS12) has more nail holes than the minimum quantity of nails specified in the table.

⁵All straps except for the MTS30 and HTS30 have the twist in the center of the strap.

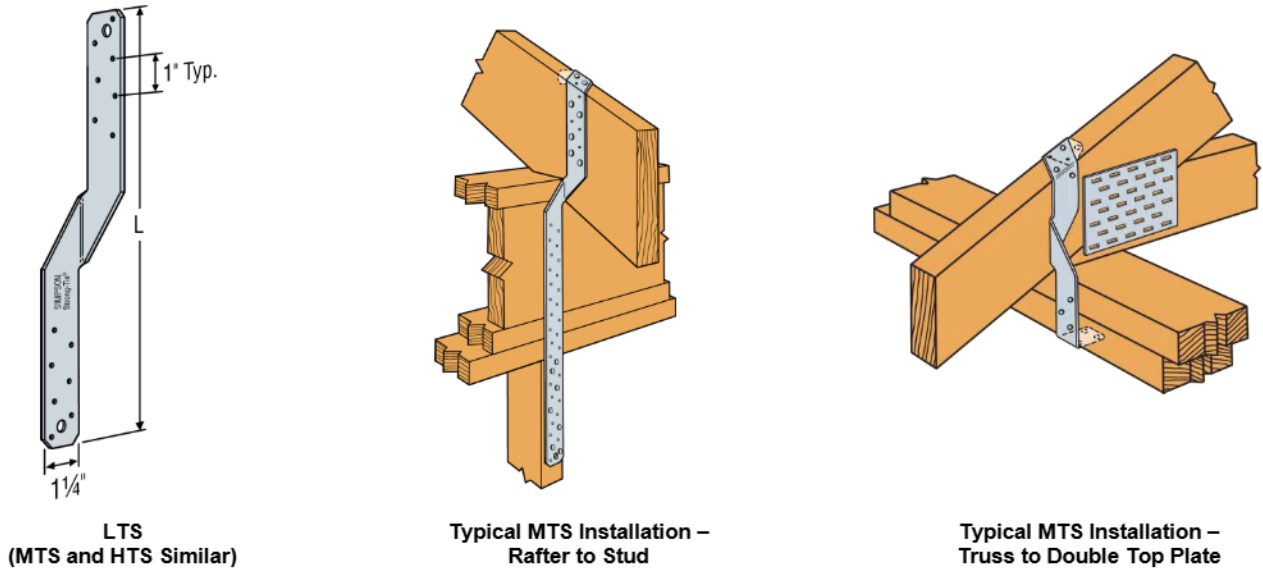

FIGURE 3—TWIST STRAPS

TABLE 4—HTSQ TWIST STRAP¹

TWIST STRAP SERIES	MODEL	STRAP LENGTH (in)	FASTENERS (Quantity-Type)	ALLOWABLE UPLIFT LOADS ^{2,3} (lbs) C _D = 1.6
HTSQ	HTSQ16KTZ	16	8- ¹ / ₄ " x 1 ¹ / ₂ " SDS	1,120
	HTSQ20KTZ	20		

For SI: 1 inch = 25.4 mm, 1 lbs = 4.45 N.

¹Half of the fasteners must be installed on each end of the strap to achieve the allowable uplift load.

²Tabulated allowable uplift loads must be selected based on duration of load as permitted by the applicable building code.

³Tabulated allowable uplift loads have been increased for wind or earthquake loading. No further increase is allowed. Allowable loads must be reduced when other load durations govern.

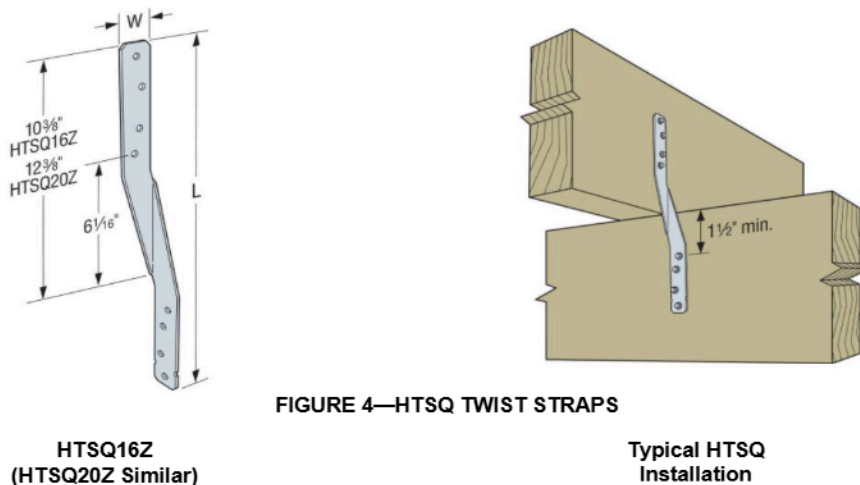

FIGURE 4—HTSQ TWIST STRAPS

TABLE 5—SP AND SPH STUD PLATE TIES

CONNECTOR SERIES	MODEL NO.	CONNECTOR DIMENSIONS (in)		FASTENERS ¹ (Quantity-Type)		ALLOWABLE UPLIFT LOADS ^{2,3,4} (lbs)	
		(W)	(L)	To Stud	To Plate	C _D = 1.6	
						S.G.=0.50	S.G.=0.55
SP	SP1	—	—	6–0.148" x 3"	4–0.148" x 3"	555	555
	SP2	—	—	6–0.148" x 3"	6–0.148" x 3"	1,010	1,010
	SP4	3 ⁹ / ₁₆	7 ¹ / ₄	6–0.148" x 3"	—	825	825
				6–0.162" x 2 ¹ / ₂ "	—	850	850
	SP6	5 ⁹ / ₁₆	7 ³ / ₄	6–0.148" x 3"	—	825	825
				6–0.162" x 2 ¹ / ₂ "	—	850	850
SP8	7 ⁵ / ₁₆	8 ⁵ / ₁₆	6–0.148" x 3"	—	825	825	
			6–0.162" x 2 ¹ / ₂ "	—	850	850	
SPH	SPH4	3 ⁹ / ₁₆	8 ³ / ₄	10–0.148" x 3"	—	1,075	1,075
				12–0.148" x 3"	—	1,195	1,195
	SPH6	5 ⁹ / ₁₆	9 ¹ / ₄	10–0.148" x 3"	—	1,075	1,075
				12–0.148" x 3"	—	1,195	1,340
	SPH8	7 ⁵ / ₁₆	8 ³ / ₈	10–0.148" x 3"	—	1,075	1,075
				12–0.148" x 3"	—	1,195	1,340

For SI: 1 inch = 25.4 mm, 1 lbs = 4.45 N.

¹For Models SP1 and SP2, one 10d common stud nail must be installed as a toenail. It must be driven through the connector at an angle approximately 30° with the stud with the nail penetrating through the stud into the wood sill plate. (See detail on this page entitled "SP1 Nailing Profile.")

²Tabulated allowable uplift loads must be selected based on duration of load as permitted by the applicable building code.

³Tabulated allowable uplift loads have been increased for wind or earthquake loading. No further increase is allowed. Allowable loads must be reduced when other load durations govern.

⁴Allowable uplift loads are given for wood assemblies consisting of lumber having an assigned specific gravity (S.G.) of 0.50, such as Douglas fir–larch, and 0.55, such as southern pine.

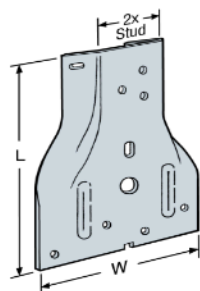

SP1/SP2

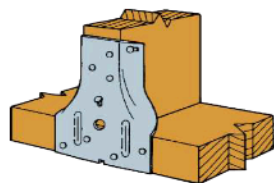

SP1 Installation:
Stud to Sill Plate

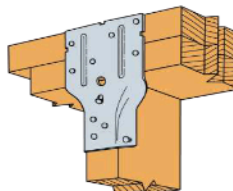

SP2 Installation:
Stud to Double Top Plate

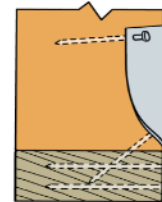

SP1 Nailing Profile

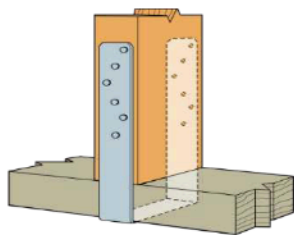

Typical SPH4 Installation:
Stud to Wood Sill Plate
(SP4 Similar)

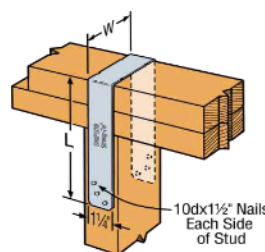

Typical SP4 Installation:
Double Top Plate

FIGURE 5—SP AND SPH STUD PLATE TIES

TABLE 6—RSP4 REVERSIBLE STUD PLATE CONNECTOR¹

MODEL NO.	FASTENERS (Quantity-Type)		ALLOWABLE LOADS ^{2,3} (lbs) C _D = 1.6			
	To Stud	To Plate	Connection Configuration ⁴	Uplift	Lateral ⁵	
					F ₁	F ₂
RSP4	4-0.131" x 1½"	4-0.131" x 1½"	Stud to Double Top Plate	390	165	245
			Stud to Sill Plate	245	165	225

For **SI**: 1 inch = 25.4 mm, 1 lbs = 4.45 N.

¹Refer to Figure 6a for overall dimensions of the RSP4 plate connector.

²Tabulated allowable loads must be selected based on duration of load as permitted by the applicable building code.

³Tabulated allowable loads have been increased for wind or earthquake loading. No further increase is allowed. Allowable loads must be reduced when other load durations govern.

⁴Refer to Figure 6b and 6c for connection configurations.

⁵F₁ load direction is parallel to plate, and F₂ load direction is perpendicular to plate.

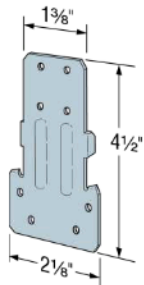

Figure 6a—RSP4 Stud Plate Connector Dimensions

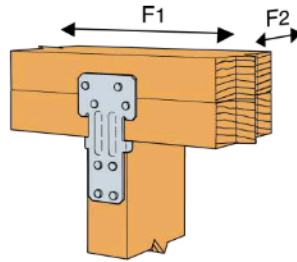

Figure 6b—RSP4 Installation: Stud to Double Top Plate

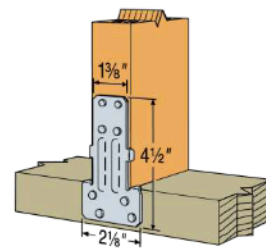

Figure 6c—RSP4 Installation: Stud to Sill Plate
U.S. Patent 5,697,725

FIGURE 6—RSP4 STUD PLATE TIES

TABLE 7—SSP, DSP, AND STUD PLATE TIE CONNECTORS

MODEL NO.	FASTENERS (Quantity-Type)			ALLOWABLE UPLIFT LOADS ^{1,2,3,4} (lbs) C _D =1.6	
	Studs	Double Top Plate	Sill Plate	Double Top Plate	Sill Plate
				S.G. = 0.50	S.G. = 0.50
SSP	4-0.148" x 1 1/2"	3-0.148" x 1 1/2"	—	330	—
		—	1-0.148" x 1 1/2"	—	395
	4-0.148" x 3"	3-0.148" x 3"	—	410	—
		—	1-0.148" x 3"	—	430
DSP	8-0.148" x 1 1/2"	6-0.148" x 1 1/2"	—	730	—
		—	2-0.148" x 1 1/2"	—	620
	8-0.148" x 3"	6-0.148" x 3"	—	780	—
		—	2-0.148" x 3"	—	780
TSP	6-0.148" x 1 1/2"	—	3-0.148" x 1 1/2"	—	465
	9-0.148" x 1 1/2"	6-0.148" x 1 1/2"	—	755 ⁵	—
		6-0.148" x 3"	—	—	1,015 ⁵

For SI: 1 inch = 25.4 mm, 1 lbs = 4.45 N.

¹Tabulated allowable uplift loads have been increased for wind or earthquake loading no further increase allowed. Reduce loads when other load durations govern.

²When cross-grain bending or cross-grain tension cannot be avoided, mechanical reinforcement to resist such forces should be considered.

³For Sill Plate allowable uplift loads, all round nail holes in the connector must be filled with the specified quantity and type of nails.

⁴For Double Top Plate allowable uplift loads, all round and triangular nail holes the tie connectors must be filled with the specified quantity and type of nails.

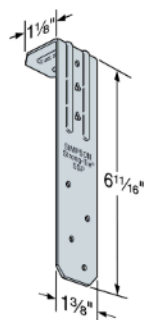

SSP
U.S. Patent
7,065,932
7,356,973

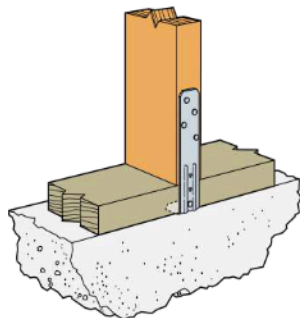

SSP Installation:
Single Stud to Sill Plate

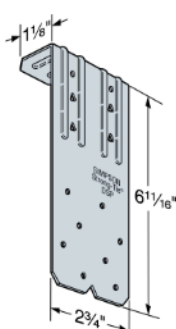

DSP
U.S. Patent
7,065,932
7,356,973

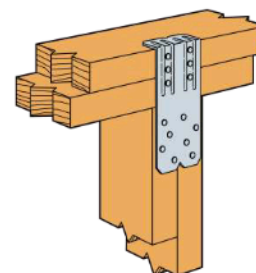

DSP Installation:
Double Stud to Double Top Plate

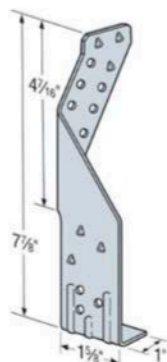

TSP
U.S. Patent
D618,085

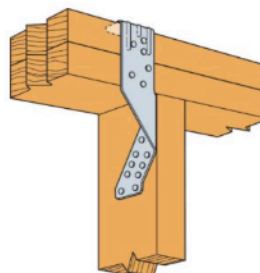

TSP Installation:
Stud to Double Top Plate

FIGURE 7—SSP/DSP/TSP STUD PLATE TIES

TABLE 8—MGT, VGT, AND HGT GIRDER TIEDOWN CONNECTORS^{1,2}

MODEL NO.	QTY.	NO. OF PLYS	DISTANCE BETWEEN THREADED RODS	FASTENERS		ALLOWABLE UPLIFT LOADS ^{5,6}
			(on center)	Threaded Rod ^{7,8}	To Truss	C _D =1.6
			(inches)	(Quantity-Diameter)	(Quantity-Type)	(lbs)
MGT ⁹	1	1 ply	—	1-5/8"	22-0.148" x 1 1/2"	3,165
	1	2 ply min.	—	1-5/8"	22-0.148" x 3"	4,365
VGT	1	2 ply min.	—	1-5/8"	16-1/4" x 3" SDS	4,940
	2	2 ply min.	—	2-5/8"	32-1/4" x 3" SDS	7,185
	2	3 ply min.	—	2-5/8"	32-1/4" x 3" SDS	8,890
VGTR/L	1	2 ply min.	—	1-5/8"	16-1/4" x 3" SDS	2,225
	2	2 ply min.	—	2-5/8"	32-1/4" x 3" SDS	5,545
HGT-2	1	2 ply ³	5 3/4	2-5/8"	16-0.148" x 3"	10,345
HGT-3	1	3 ply ^{3,4}	7 3/8	2-5/8"	16-0.148" x 3"	10,440
HGT-4	1	4 ply ³	9	2-5/8"	16-0.148" x 3"	11,395

For SI: 1 inch = 25.4mm, 1 lbs = 4.45 N.

¹The HGT connector can accommodate top chord slopes from minimum 3:12 (14°) to maximum 8:12 (34°) and are provided with crescent washers for sloped top chord installations. The VGT and VGTR/L connectors can accommodate roof slopes up to 8:12 (34°).

²All elements of the tie-down assembly (multi-ply trusses, vertically aligned wood studs/posts, and the threaded rods) must be designed to resist applied loads.

³W dimensions for the HGT-2, HGT-3, and HGT-4 connectors are 3⁹/₁₆", 4¹⁵/₁₆", and 6⁹/₁₆", respectively.

⁴When the HGT-3 is used with a two-ply truss, shimming is required, and the shimming material must be similar (thickness and grade of lumber) as the truss member material. Additionally, the entire assembly must be designed by a registered design professional to act as one unit.

⁵Tabulated allowable loads must be selected based on duration of load as permitted by the applicable building code.

⁶The uplift loads have been increased for wind or earthquake loading with no further increase is allowed. Reduce loads when other load durations govern.

⁷Full-height threaded rods or inverted holdowns are shown in Figure 8 for illustration purposes only, as one method of transferring the design load from the MGT, VGT, VGTR/L, and HGT connectors to the foundation or structure below. The threaded rod material specifications must be specified by the registered design professional.

⁸For HGT models, Two LBP 5/8-inch washers must be installed on top of each crescent washer. LBP washers and crescent washers are required. Crescent washers are supplied with the connector. LBP washers are available from Simpson Strong-Tie Company, and are 2-inch square by 5/84-inch thick galvanized steel washers with a center bolt hole to accommodate a 5/8-inch diameter threaded bolt/rod.

⁹MGT may be installed with straps vertical for full table load, provided that all specified nails are installed to either a solid beam or minimum 2x6 truss web.

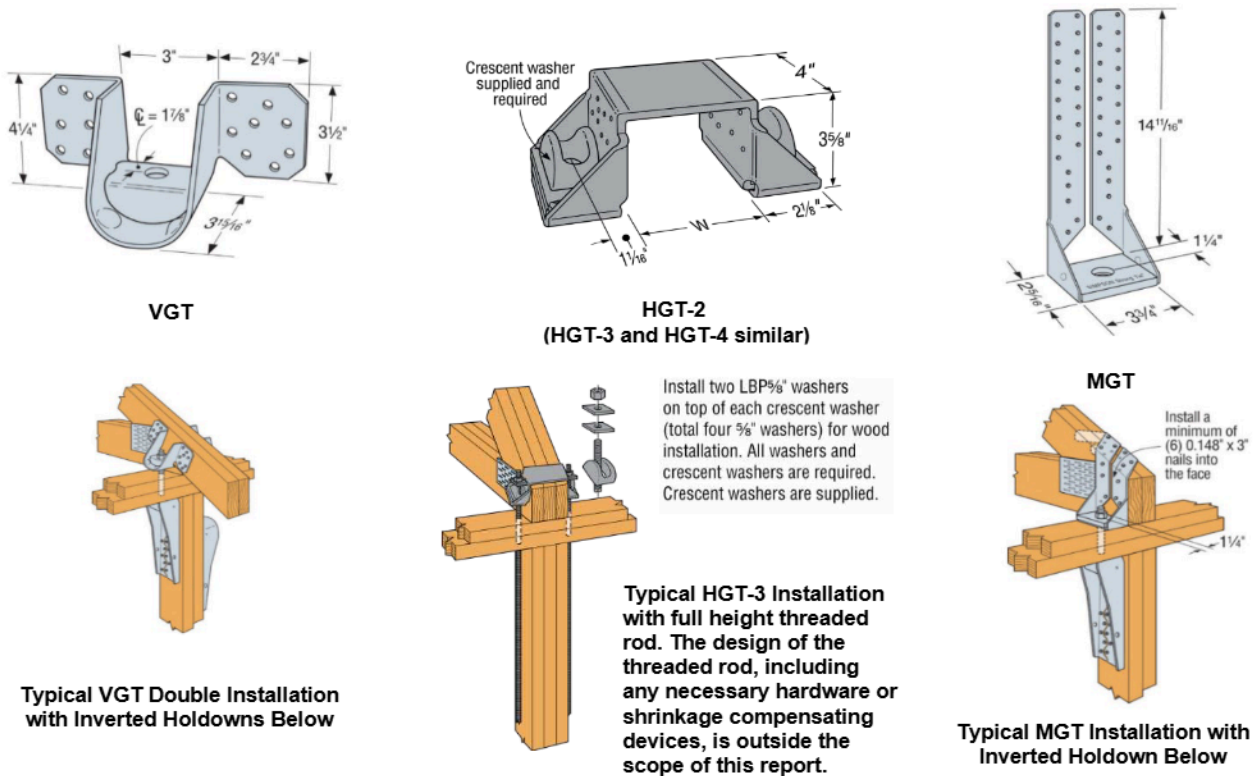

FIGURE 8—HGT HEAVY GIRDER TIEDOWN CONNECTOR

DIVISION: 06 00 00—WOOD, PLASTICS AND COMPOSITES
Section: 06 05 23—Wood, Plastic, and Composite Fastenings

REPORT HOLDER:

SIMPSON STRONG-TIE COMPANY INC.

EVALUATION SUBJECT:

SIMPSON STRONG-TIE® HURRICANE AND SEISMIC STRAPS AND TIES FOR WOOD FRAMING

1.0 REPORT PURPOSE AND SCOPE

Purpose:

The purpose of this evaluation report supplement is to indicate that Simpson Strong-Tie® hurricane and seismic straps and ties for wood framing, described in ICC-ES evaluation report [ESR-2613](#), have also been evaluated for compliance with the codes noted below as adopted by the Los Angeles Department of Building and Safety (LADBS).

Applicable code editions:

- 2023 *City of Los Angeles Building Code* (LABC)
- 2023 *City of Los Angeles Residential Code* (LARC)

2.0 CONCLUSIONS

The Simpson Strong-Tie® hurricane and seismic straps and ties for wood framing, described in Sections 2.0 through 7.0 of the evaluation report [ESR-2613](#), comply with the LABC Chapter 23, and the LARC, and are subjected to the conditions of use described in this supplement.

3.0 CONDITIONS OF USE

The Simpson Strong-Tie® hurricane and seismic straps and ties for wood framing, described in this evaluation report supplement must comply with all of the following conditions:

- All applicable sections in the evaluation report [ESR-2613](#).
- The design, installation, conditions of use and identification are in accordance with the 2021 *International Building Code*® (IBC) provisions noted in the evaluation report [ESR-2613](#).
- The design, installation and inspection are in accordance with additional requirements of LABC Chapters 16 and 17, as applicable.
- In accordance with LABC Section 2305.5, allowable seismic load values of Simpson Strong-Tie straps and ties used as hold-down connectors must be 75 percent of those in the evaluation report [ESR-2613](#).
- Under the LARC, an engineered design in accordance with LARC Section R301.1.3 must be submitted.
- The seismic design provisions for hillside buildings referenced in LABC Section 2301.1 have not been considered and are outside of the scope of this supplement.

This evaluation report supplement expires concurrently with the evaluation report [ESR-2613](#), reissued June 2024.

DIVISION: 06 00 00—WOOD, PLASTICS, AND COMPOSITES
Section: 06 05 23—Wood, Plastic, and Composite Fastenings

REPORT HOLDER:

SIMPSON STRONG-TIE COMPANY INC.

EVALUATION SUBJECT:

SIMPSON STRONG-TIE® HURRICANE AND SEISMIC STRAPS AND TIES FOR WOOD FRAMING

1.0 REPORT PURPOSE AND SCOPE**Purpose:**

The purpose of this evaluation report supplement is to indicate that the Simpson Strong-Tie® hurricane and seismic straps and ties, described in ICC-ES evaluation report ESR-2613, have also been evaluated for compliance with the codes noted below.

Applicable code editions:

- 2023 *Florida Building Code—Building*
- 2023 *Florida Building Code—Residential*

2.0 CONCLUSIONS

The Simpson Strong-Tie® hurricane and seismic straps and ties, described in Sections 2.0 through 7.0 of ICC-ES evaluation report ESR-2613, comply with the *Florida Building Code—Building*, and the *Florida Building Code—Residential*. The design requirements must be determined in accordance with the *Florida Building Code—Building* or the *Florida Building Code—Residential*, as applicable. The installation requirements noted in ICC-ES evaluation report ESR-2613 for the 2021 *International Building Code*® meet the requirements of the *Florida Building Code—Building* or the *Florida Building Code—Residential*, as applicable.

Use of the Simpson Strong-Tie® hurricane and seismic straps and ties has also been found to be in compliance with the High-Velocity Hurricane Zone provisions of the *Florida Building Code—Building*, and the *Florida Building Code—Residential* with the following condition:

- a. For connections subject to uplift, the connection must be designed for no less than 700 pounds (3114 N).

For products falling under Florida Rule 61G20-3, verification that the report holder's quality assurance program is audited by a quality assurance entity approved by the Florida Building Commission for the type of inspections being conducted is the responsibility of an approved validation entity (or the code official when the report holder does not possess an approval by the Commission).

This evaluation report supplement expires concurrently with the ICC-ES evaluation report ESR-2613, reissued June 2024.